

# INSTALLATION & OPERATION INSTRUCTIONS



The **Santa Fe Classic** has a vertical configuration and its' flow-down design performs exceptionally well in basements. The high capacity blower on the unit moves air in a way that no small conventional unit can. The Classic's optional condensate pump and ducting kits provide the flexibility necessary for any application.

Serial Number \_\_\_\_\_

Install Date \_\_\_\_\_

Sold By \_\_\_\_\_



**SANTA-FE™**  
**6-YEAR** TOTAL PEACE OF MIND  
WARRANTY  
5-YEAR FULL REPLACEMENT + 1-YEAR PARTS



ENGINEERED  
& ASSEMBLED  
★  
MADISON, WI

Patent: [thermastor.com/patents](http://thermastor.com/patents)

# Table of Contents

|  |           |
|--|-----------|
| <b>Safety Instructions</b> .....                 | <b>3</b>  |
| <b>Intended Applications</b> .....               | <b>4</b>  |
| Registrations and Certifications .....           | 4         |
| Items Included In Box.....                       | 4         |
| <b>Dehumidifier Set Up</b> .....                 | <b>5</b>  |
| Location Considerations.....                     | 5         |
| Unventilated Areas .....                         | 5         |
| Installing Leveling Feet .....                   | 5         |
| <b>Drain Installation</b> .....                  | <b>6</b>  |
| <b>Operation</b> .....                           | <b>7</b>  |
| Humidity Control Adjustment .....                | 7         |
| Defrost Cycle .....                              | 7         |
| Fan Operation .....                              | 7         |
| <b>Air Filtration</b> .....                      | <b>8</b>  |
| Changing The Filter .....                        | 8         |
| <b>Ducting to Finished Area (Optional)</b> ..... | <b>9</b>  |
| Attaching Duct Collars .....                     | 9         |
| Recommended Installations.....                   | 10        |
| <b>Service</b> .....                             | <b>11</b> |
| Troubleshooting .....                            | 15        |
| Refrigerant Charging .....                       | 16        |
| Compressor / Capacitor Replacement.....          | 16        |
| <b>Electrical Requirements</b> .....             | <b>17</b> |
| <b>Warranty</b> .....                            | <b>18</b> |



4201 Lien Rd. Madison, WI 53704

1-800-533-7533

[www.Thermastor.com](http://www.Thermastor.com) | [www.Santa-Fe-Products.com](http://www.Santa-Fe-Products.com)

© 2016 Therma-Stor LLC

# Safety Instructions

READ THE INSTALLATION, OPERATION AND MAINTENANCE INSTRUCTIONS CAREFULLY BEFORE INSTALLING AND OPERATING THIS DEVICE. PROPER ADHERENCE TO THESE INSTRUCTIONS IS ESSENTIAL TO OBTAIN MAXIMUM BENEFIT FROM YOUR SANTA FE DEHUMIDIFIER.

## **WARNING!**

THIS SYMBOL MEANS IMPORTANT INSTRUCTIONS. FAILURE TO HEED THEM CAN RESULT IN SERIOUS INJURY OR DEATH.

## **CAUTION!**

THIS SYMBOL MEANS IMPORTANT INSTRUCTIONS. FAILURE TO HEED THEM CAN RESULT IN INJURY OR MATERIAL PROPERTY DAMAGE.

- Never operate the dehumidifier with a damaged power cord. If the power cord is damaged, it must be replaced by the manufacturer, its service agent, or a similarly qualified person in order to avoid a hazard.
- Do not unplug the dehumidifier by pulling on the cord. Grasp the plug firmly and pull it out of the wall socket or power receptacle.
- When plugging in the dehumidifier, use a Ground Fault Interrupter outlet.
- This appliance is not intended for use by persons (including children) with reduced physical, sensory or mental capabilities, or lack of experience or knowledge, unless they have been given supervision or instruction concerning the use of the appliance by a person responsible for their safety. Children should be supervised to ensure that they do not play with the appliance.
- Never operate electrical equipment near or in standing water.
- Do not stick your fingers or other objects through the safety grill.
- The dehumidifier must be used in the upright position.
- When changing filters, do not stick fingers or other objects in the dehumidifier and make sure it is off.
- Do not restrict airflow in to or out of the dehumidifier. This may cause it to overheat.
- The dehumidifier should never be serviced or cleaned while it is plugged in.
- Do not sit or stand on the dehumidifier, or use as a shelf or table.
- Before leaving the dehumidifier unattended, ensure children do not have access to the equipment. Do not allow children to play with or near the unit or in its air flow.
- The dehumidifier is designed to be installed indoors only in a space that is protected from rain and flooding.
- Install the dehumidifier with space to access the back or side panels for maintenance and service. DO NOT INSTALL DEHUMIDIFIER WITH THE SERVICE PANELS INACCESSIBLE. The entire shell needs to be removed in order to do repairs.
- Avoid directing the discharge air at people, or over the water in pool areas.
- If used near a pool, spa, or water; be certain there is NO chance the dehumidifier could fall into the water, be splashed and that it is plugged into an outlet that is a GROUND FAULT INTERRUPT protected circuit.
- If the supply cord is damaged, it must be replaced by the manufacturer, its service agent or similarly qualified persons in order to avoid a hazard.
- DO NOT place the dehumidifier directly on structural members. Provide vibration isolation in order to minimize operational vibration and/or noise.
- A drain pan MUST be placed under the unit if installed above a living area or above an area where water leakage could cause damage
- Make all electrical connections in accordance with the current edition of the NEC ANSI/NFPA 70 and any national and local codes or ordinances that may apply.
- Maintain a minimum 1ft. (.3m) clearance to avoid obstructing the air return and supply.
- Not intended for use at altitudes over 6500 ft (2000M).
- The minimum floor area of the storage room shall be 28 m<sup>2</sup> (square meters).
- Contact installer or call 1-800-533-7533 for all repair or warranty needs.



**REFRIGERANT  
SAFETY GROUP  
A2L**

## **WARNING!**

Do not use means to accelerate the defrosting process or to clean, other than those recommended by the manufacturer. The appliance shall be stored in a room without continuously operating ignition sources (for example: open flames, an operating gas appliance, or an operating electric heater. Do not pierce or burn. Be aware that refrigerants may not contain an odor.

# Intended Applications

---

The Santa Fe Classic is registered with the DOE as a portable dehumidifier with a capacity greater than 50 pints per day. It is a stand-alone dehumidifier intended to operate within the dehumidified space, such as basements: however, the unit can be placed in almost any residential setting where dehumidification is desired.

The Santa Fe Classic is designed to operate in temperatures between 49° and 95°F. This unit works most effectively between 56° and 95°.

In order to efficiently control humidity levels, the area in which the dehumidifier is to be operated must be free of water intrusion or excessive fresh (outside) air infiltration. Before installing the Santa Fe Classic, water intrusion and air infiltration problems should be addressed.

## Registrations and Certifications



The Santa Fe Classic conforms to unified standard UL 60335-2-40 and CSA standard C22.2.60335-2-40.

The Santa Fe Classic is certified as a "Portable Dehumidifier" per 10CFR430 - Energy Conservation Program for Consumer Products

| Brand Name       | Individual Model Number | Basic Model Number | Rating Conditions | Integrated Energy Factor (L/kWh) | Capacity (Pint/Day) |
|------------------|-------------------------|--------------------|-------------------|----------------------------------|---------------------|
| Santa Fe Classic | 4044710                 | 110V.1-P           | 65F/60%           | 2.82                             | 76                  |

When unpacking make sure to remove corrugated shipping cardboard from top of unit.

## Items Included in Box:

- Santa Fe Classic Dehumidifier
- Santa Fe Classic Installation & Operation Instructions
- MERV-13 Filter (Dimensions: 16" x 20" x 2")
- Drain Hose Attached to Dehumidifier (6')

# Dehumidifier Set Up

## Location Considerations

- Do not install the Santa Fe Classic with the intake or exhaust of the unit within 1' of a wall or other obstruction. Avoid directing the discharge air at people. The dehumidifier should be used in the upright position.
- Do not place the unit where curtains or debris can be drawn into the intake and restrict airflow.
- Locate the dehumidifier near a suitable drain (6' drain hose included). Allow for proper drainage and routing of needed drain pipes.
- Locate the dehumidifier in an area where the cord's length (9') easily reaches a 115 VAC electrical outlet with a minimum of a 15 Amp circuit capacity.
- The unit is designed to operate while level. Failure to level the unit may result in leakage or improper drainage.
- A flooded unit is not covered by warranty.
- Allow sufficient clearance to handle the unit's overall dimensions as well as any optional return and supply ductwork to the unit.
- Allow sufficient clearance for filter removal and to prevent airflow obstruction.
- Electrical service access will require the removal of the front panel. Allow sufficient clearance around the unit.
- Keep any required ventilation openings clear of obstruction.
- Ducts connected to the dehumidifier shall not contain a POTENTIAL IGNITION SOURCE.
- Supply and return air shall be directly ducted to the space. Open areas such as false ceilings shall not be used as a return air duct.

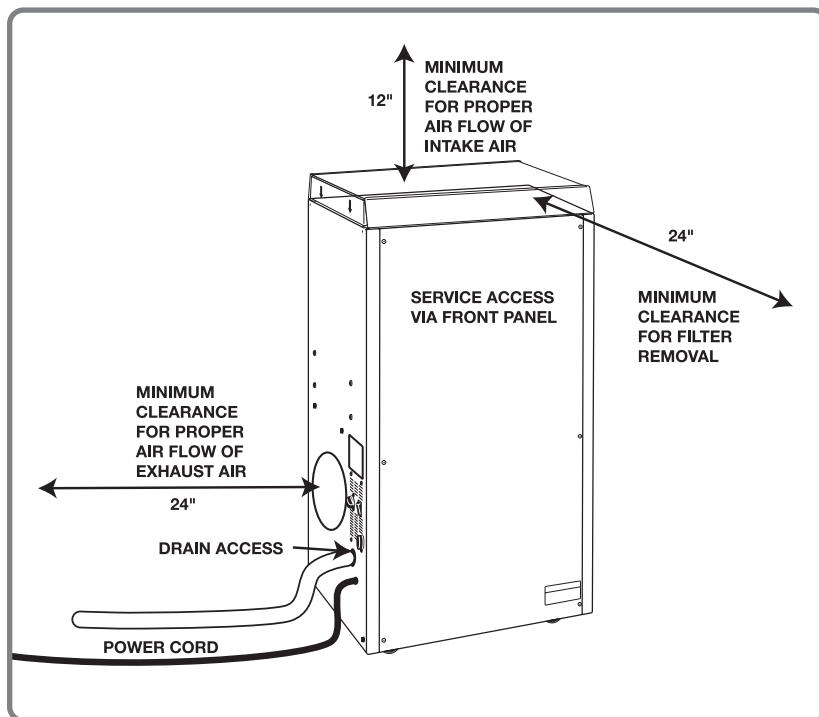

## Unventilated Areas:

- Unventilated areas where the dehumidifier is installed or stored need to be so constructed that should any refrigerant leak, it will not stagnate so as to create a fire or explosion hazard.
- The dehumidifier shall not be stored or ducted into one or multiple rooms with continuously operating open flames (for example an operating gas appliance) or other POTENTIAL IGNITION SOURCES (for example an operating electric heater, hot surfaces). A flame-producing device may be installed in the same space if the device is provided with an effective flame arrest.

## Installing Leveling Feet

- Lay down a protective pad (pillow, blanket, etc.).
- Carefully turn unit onto side.
- Install leveling feet and adjust to the desired position to ensure unit is level for proper drainage.
- Carefully bring unit to upright position.
- Wait a minimum of 10 minutes before operating.

# Drain Installation

The Santa Fe Classic generates condensate. A 6' condensate hose comes attached to the unit. Be sure the hose is not kinked or otherwise restricted so water can pass through the hose freely. If the Santa Fe Classic is located too far from the floor drain and the provided hose does not reach, you may use a 1/2" PVC rigid pipe to extend the drain. Rigid PVC tubing is readily available from your local hardware store. Be sure the extension is at a downward slope to the drain.

An optional condensate pump kit is available for use with the Santa Fe Classic and may be installed if lift is required to dispose of condensate. Condensate is automatically pumped to a remote location when the water level in the pump's reservoir rises to close the float switch.

Note: An optional condensate pump kit (Part # 4022220) can be purchased from a local dealer or online.

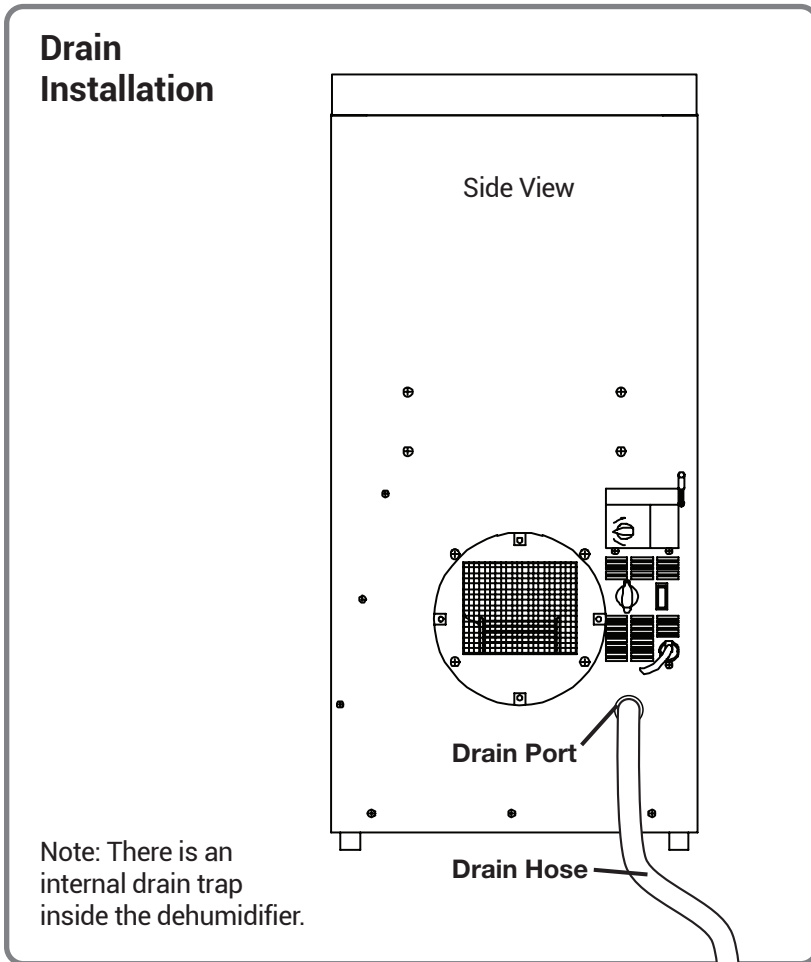

## **⚠ CAUTION!**

**CHECK DRAIN HOSE WHEN CHANGING FILTER TO ENSURE THERE IS NOT BUILD UP OF ALGAE OR SLUDGE.**

# Operation

## Humidity Control Adjustment

The humidity control is an adjustable switch that turns the dehumidifier on and off. It turns on when the relative humidity (RH) rises to the dial set point. It turns off when the RH is within  $\pm 5\%$  of the set point.

### Approximate Humidity Levels Per Setting

|          |  |
|----------|--|
| "Drier"  | 35% to 45% Relative Humidity   |
| "Normal" | 45% to 55% Relative Humidity<br><b>(Recommended for most applications)</b> |
| "Humid"  | 55% to 65% Relative Humidity   |

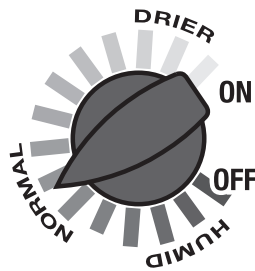

### FAN SWITCH

**FAN ON:** Fan runs continuously



**FAN AUTO:**  
Fan runs only while dehumidifying

## CAUTION!

The dehumidifier will run continuously until the RH is reduced to the humidity control dial setting. It is not recommended to set the humidity control to "dry" in rooms under 65°; doing so will result in long periods of ineffective dehumidifier run time.

To turn unit on, turn the humidity dial clockwise to the recommended "NORMAL" position and set fan control to "FAN AUTO." To turn the unit off, turn the humidity dial counter clockwise to the "OFF" position and set fan control to "FAN AUTO."

## Defrost Cycle

This product includes a defrost thermostat. This feature prevents internal damage caused by excessive frost forming within the unit. When the unit is experiencing excessive frost the system will stop dehumidifying and the fan will run until normal operating conditions are present.

## Fan Operation

Turning the fan switch "FAN ON" will cause the unit's internal blower to run continuously, whether the unit is dehumidifying or not. This function is desirable if the unit is used for air circulation or filtration. Turning the fan switch to "FAN AUTO" (recommended) will cause the unit's internal blower to run only while the unit is dehumidifying.

# Air Filtration

The Santa Fe Classic is equipped with a MERV-13 air filter (89-90% ASHRAE dust spot). An optional MERV-11 filter is available at [www.ThermastorFilters.com](http://www.ThermastorFilters.com). The MERV-13 filter should be checked and replaced every three to six months. Operating the unit with a dirty filter will reduce dehumidifier capacity and efficiency.

DO NOT operate the unit without the standard MERV-13 or optional MERV-11 filter. Filter non-compliance voids the product warranty.

## CAUTION!

**MAKE SURE UNIT IS OFF BEFORE CHANGING THE FILTER. FAILURE TO FOLLOW FILTER HANDLING INSTRUCTIONS MAY RESULT IN IMPROPER FUNCTION OF THE DEHUMIDIFIER AND CAUSE PREMATURE FILTER WEAR OR UNIT DAMAGE.**

### Changing the Filter

For greatest filtration and efficiency of the Santa Fe Classic, it is recommended that the MERV-13 filter be replaced every three to six months

**Step 1** - Remove the filter by pulling it gently out of the unit from the front side.

**Step 2** - Insert the new filter by gently sliding it back into place inside the unit. Be sure the arrows on the filter are pointing down towards the unit.

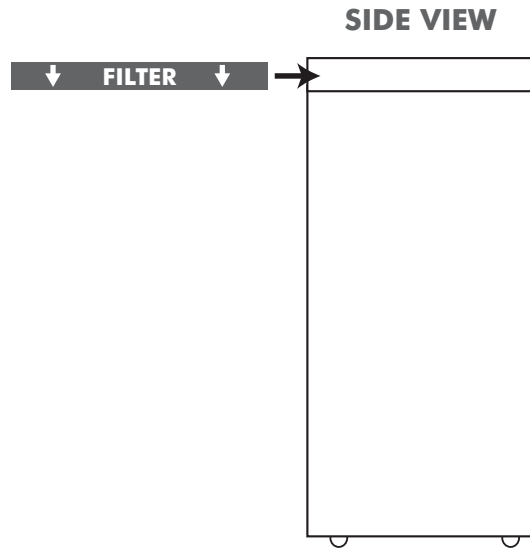
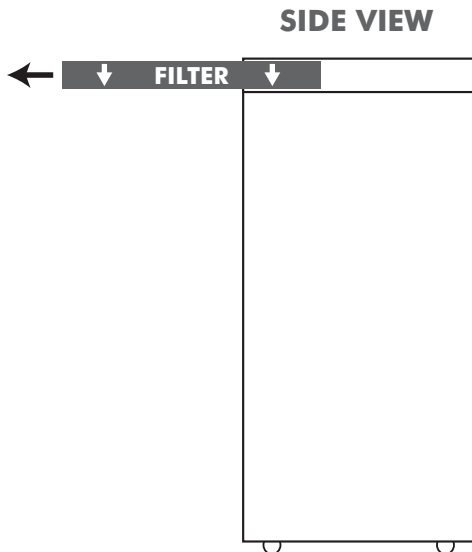

## CAUTION!

**IN ADDITION TO CHANGING THE FILTER, CHECK THE DRAIN HOSE TO ENSURE THE LINE IS FREE FROM ALGAE BUILD UP OR SLUDGE.**



# Ducting To Finished Area (Optional)

---

## Attaching Duct Collars

### Return Air Inlet Hood

The return air inlet hood has an 8" and 6" diameter collar. The 8" collar is the main return collar and must be used. The 6" collar is optional and can be left closed to draw air from another location.

### Supply Air Outlet

The 8" supply collar is included in the return duct kit and also sold separately.

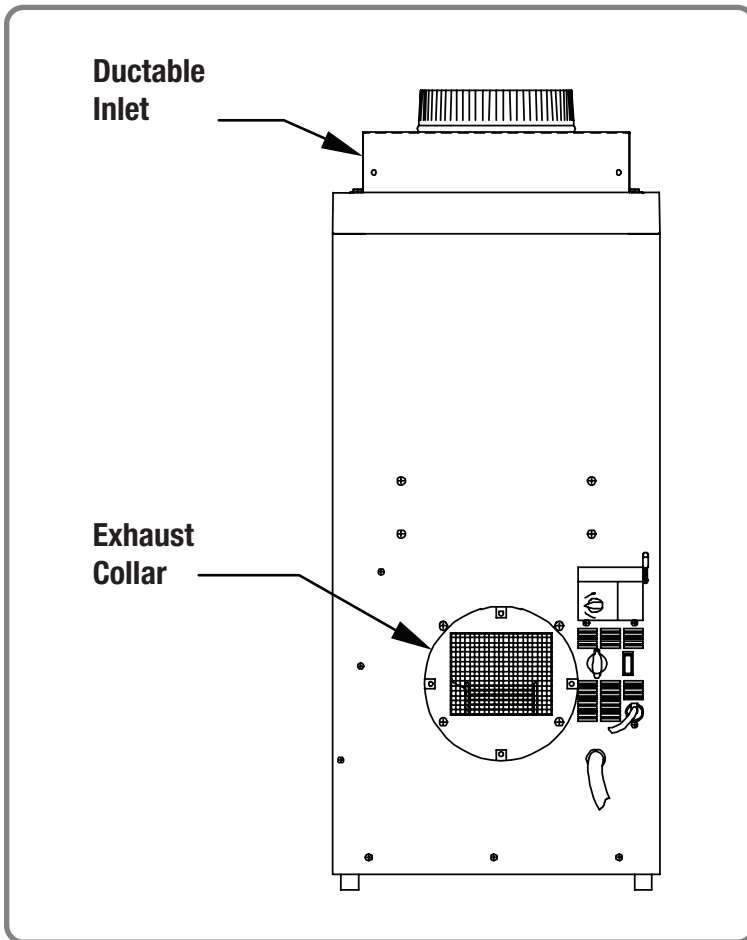

# Ducting To Finished Area (Optional)

## Recommended Installations

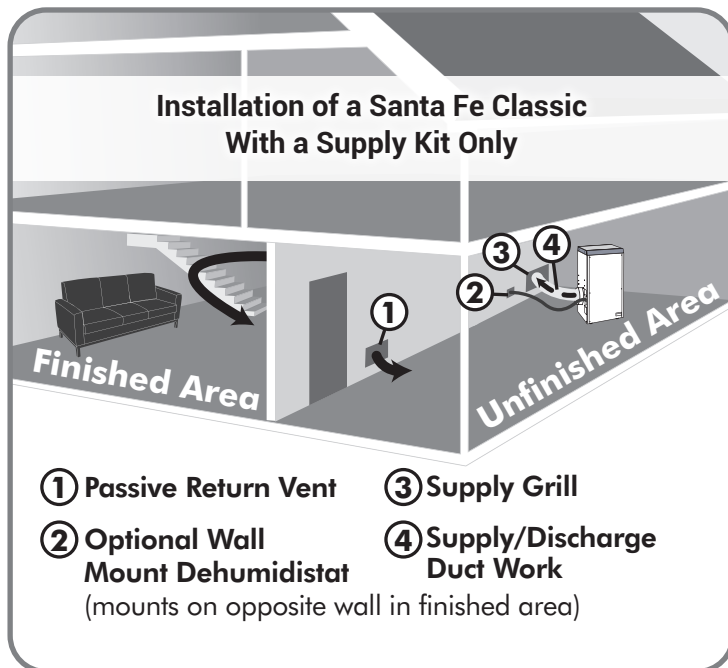

- Place the Santa Fe Classic in the unfinished area of the basement, near a drain access (condensate will drain via gravity or with an optional pump kit).
- Using the supply duct collar, supply the dry air from the dehumidifier into a large, open room in the finished section of the basement.
- Place a return grill / passive vent on the other side of the wall that separates the finished and unfinished area. This will allow for a circular air flow throughout the basement.
- The passive grill will prevent the unfinished room from being placed under a negative pressure and also allow the dehumidifier to focus on keeping the unfinished area dry as well.
- The onboard dehumidistat control can be used on the unit for this application or a 120 volt dehumidistat can be placed in the finished basement as well (we recommend using an electrician to run the wiring).

# Service

---

## **WARNING!**

**SERVICING THE DEHUMIDIFIER WITH ITS HIGH PRESSURE REFRIGERANT SYSTEM AND HIGH VOLTAGE CIRCUITRY PRESENTS A HEALTH HAZARD WHICH COULD RESULT IN DEATH, SERIOUS BODILY INJURY, AND/OR PROPERTY DAMAGE. ONLY QUALIFIED SERVICE PEOPLE SHOULD SERVICE THIS UNIT.**

## Warranty

A warranty certificate has been enclosed in this manual; read it before any repair is initiated. If a warranty repair is required, call the factory first at 1-877-420-1330 for warranty claim authorization and technical assistance.

## Technical Description

The dehumidifier uses a refrigeration system similar to an air conditioner's to remove heat and moisture from incoming air, and add heat to the air that is discharged.

Hot, high-pressure refrigerant gas is routed from the compressor to the condenser coil. The refrigerant is cooled and condensed by giving up its heat to the air that is about to be discharged from the unit. The refrigerant liquid then passes through a filter/drier and expansion device which causes the refrigerant pressure and temperature to drop. It next enters the evaporator coil where it absorbs heat from the incoming air and evaporates. The evaporator operates in a flooded condition, which means that all the evaporator tubes contain liquid refrigerant during normal operation. A flooded evaporator should maintain nearly constant pressure and temperature across the entire coil, from inlet to outlet.

The compressor collects the cool refrigerant gas and compresses it to a high pressure and temperature to repeat the process.

## Service Personnel

Only qualified HVAC or electrical contractors are allowed to conduct maintenance, service and/or repair operations on the dehumidifier. Examples include but are not limited to breaking into the refrigerating circuit, opening of sealed components, and/or opening of ventilated enclosures.

- Prior to beginning work on the dehumidifier, safety checks are necessary to ensure that the risk of ignition is minimized.
- For repair to the REFRIGERATING SYSTEM, a qualified contractor should first establish a controlled procedure so as to minimize the risk of a flammable gas or vapor being present while the work is being performed
- All maintenance staff and others working in the local area shall be instructed on the nature of work being carried out. Work in confined spaces shall be avoided.
- The area shall be checked with an appropriate refrigerant detector prior to and during work, to ensure the technician is aware of potentially toxic or flammable atmospheres. Ensure that the leak detection equipment being used is suitable for use with all applicable refrigerants, i.e. non-sparking, adequately sealed or intrinsically safe.
- If any hot work is to be conducted on the refrigerating equipment or any associated parts, appropriate fire extinguishing equipment shall be available to hand. Have a dry powder or CO2 fire extinguisher adjacent to the charging area.
- No person carrying out work in relation to a REFRIGERATING SYSTEM which involves exposing any pipe work shall use any sources of ignition in such a manner that it may lead to the risk of fire or explosion. All possible ignition sources, including cigarette smoking, should be kept sufficiently far away from the site of installation, repairing, removing and disposal, during which refrigerant can possibly be released to the surrounding space. Prior to work taking place, the area around the equipment is to be surveyed to make sure that there are no flammable hazards or ignition risks. "No Smoking" signs shall be displayed.
- Ensure that the area is in the open or that it is adequately ventilated before breaking into the system or conducting any hot work. A degree of ventilation shall continue during the period that the work is carried out. The ventilation should safely disperse any released refrigerant and preferably expel it externally into the atmosphere.

# Service

---

## **The following checks shall be applied to installations using FLAMMABLE REFRIGERANTS:**

- Where electrical components are being changed, they shall be fit for the purpose and to the correct specification. At all times Therma-Stor's maintenance and service guidelines shall be followed. If in doubt, consult Therma-Stor's technical department for assistance.
- The actual REFRIGERANT CHARGE is in accordance with the room size within which the refrigerant containing parts are installed;
- The ventilation machinery and outlets are operating adequately and are not obstructed;
- Marking to the equipment continues to be visible and legible. Markings and signs that are illegible shall be corrected;
- Dehumidifiers are installed in a position where they are unlikely to be exposed to any substance which may corrode refrigerant containing components, unless the components are constructed of materials which are inherently resistant to being corroded or are suitably protected against being so corroded.

## **Checks to Electrical Devices**

Repair and maintenance to electrical components shall include initial safety checks and component inspection procedures. If a fault exists that could compromise safety, then no electrical supply shall be connected to the circuit until it is satisfactorily dealt with. If the fault cannot be corrected immediately but it is necessary to continue operation, an adequate temporary solution shall be used. This shall be reported to the owner of the equipment so all parties are advised.

Initial safety checks shall include:

- that capacitors are discharged: this shall be done in a safe manner to avoid possibility of sparking;
- that no live electrical components and wiring are exposed while charging, recovering or purging the system;
- that there is continuity of earth bonding;

## **Sealed Electrical Components Shall Be Replaced**

- During repairs to sealed components, all electrical supplies shall be disconnected from the equipment being worked upon prior to any removal of sealed covers, etc. If it is absolutely necessary to have an electrical supply to equipment during servicing, then a permanently operating form of leak detection shall be located at the most critical point to warn of a potentially hazardous situation.
- Particular attention shall be paid to the following to ensure that by working on electrical components, the casing is not altered in such a way that the level of protection is affected. This shall include damage to cables, excessive number of connections, terminals not made to original specification, damage to seals, incorrect fitting of glands, etc.
- Ensure that the equipment is mounted securely.
- Ensure that seals or sealing materials have not degraded to the point that they no longer serve the purpose of preventing the ingress of flammable atmospheres.
- Replacement parts shall be in accordance with Therma-Stor specifications.

## **Intrinsically Safe Components Must Be Replaced**

- Do not apply any permanent inductive or capacitance loads to the circuit without ensuring that this will not exceed the permissible voltage and current permitted for the equipment in use.
- Intrinsically safe components are the only types that can be worked on while live in the presence of a flammable atmosphere. The test apparatus shall be at the correct rating.
- Replace components only with parts specified by Therma-Stor. Other parts may result in the ignition of refrigerant in the atmosphere from a leak.

**NOTE:** The use of silicon sealant can inhibit the effectiveness of some types of leak detection equipment. Intrinsically safe components do not have to be isolated prior to working on them.

Check that cabling will not be subject to wear, corrosion, excessive pressure, vibration, sharp edges or any other adverse environmental effects. The check shall also take into account the effects of aging or continual vibration from sources such as compressors or fans.

# Service

---

## Detection of Flammable Refrigerants

Under no circumstances shall potential sources of ignition be used in the searching for or detection of refrigerant leaks. A halide torch (or any other detector using a naked flame) shall not be used.

The following leak detection methods are deemed acceptable for all refrigerant systems:

- Electronic leak detectors may be used to detect refrigerant leaks but, in the case of FLAMMABLE REFRIGERANTS, the sensitivity may not be adequate, or may need re-calibration. (Detection equipment shall be calibrated in a refrigerant-free area.) Ensure that the detector is not a potential source of ignition and is suitable for the refrigerant used. Leak detection equipment shall be set at 25% LFL of the refrigerant and shall be calibrated to 454B.
- Leak detection fluids are also suitable for use with most refrigerants but the use of detergents containing chlorine shall be avoided as the chlorine may react with the refrigerant and corrode the copper pipe.

**NOTE:** Examples of leak detection fluids are:

- bubble method
- fluorescent method agents.
- If a leak is suspected, all open flames shall be removed/extinguished.

If a leakage of refrigerant is found which requires brazing, all of the refrigerant shall be recovered from the system, or isolated (by means of shut off valves) in a part of the system remote from the leak. Removal of refrigerant shall be according to Clause DD.9 of 60335-2-40.

## Refrigerant Removal and Evacuation

When breaking into the refrigerant circuit to make repairs – or for any other purpose – conventional procedures shall be used. However, for FLAMMABLE REFRIGERANTS it is important that best practice is followed since flammability is a consideration. The following procedure shall be adhered to:

- Safely remove refrigerant following local and national regulations.
- The REFRIGERANT CHARGE shall be recovered into the correct recovery cylinders if venting is not allowed by local and national codes.
- For appliances containing flammable refrigerants, the system shall be purged with oxygen-free nitrogen to render the appliance safe for flammable refrigerants.
- This process might need to be repeated several times. Compressed air or oxygen shall not be used for purging refrigerant systems.
- When the final oxygen-free nitrogen charge is used, the system shall be vented down to atmospheric pressure to enable work to take place.
- Open the circuit by cutting or brazing.
- Ensure that the outlet for the vacuum pump is not close to any POTENTIAL IGNITION SOURCES and that ventilation is available.

## Charging Procedures

In addition to conventional charging procedures, the following requirements shall be followed:

- Ensure that contamination of different refrigerants does not occur when using charging equipment. Hoses or lines shall be as short as possible to minimize the amount of refrigerant contained in them.
- Cylinders shall be kept in an appropriate position according to the instructions.
- Ensure that the REFRIGERATING SYSTEM is grounded prior to charging the system with refrigerant.
- Label the system when charging is complete (if not already).
- Extreme care shall be taken not to overfill the REFRIGERATING SYSTEM.
- Prior to recharging the system, it shall be pressure-tested with the appropriate purging gas. The system shall be leak-tested on completion of charging but prior to commissioning. A follow up leak test shall be carried out prior to leaving the site.

# Service

---

## Decommissioning

Before carrying out this procedure, it is essential that the technician is completely familiar with the equipment and all its details. It is recommended good practice that all refrigerants are recovered safely. Prior to the task being carried out, an oil and refrigerant sample shall be taken in case analysis is required prior to re-use of recovered refrigerant. It is essential that electrical power is available before the task commences.

- Become familiar with the equipment and its operation.
- Isolate system electrically.

### Before attempting the procedure, ensure that:

- mechanical handling equipment is available, if required, for handling refrigerant cylinders;
  - all personal protective equipment is available and being used correctly;
  - the recovery process is supervised at all times by a competent person;
  - recovery equipment and cylinders conform to the appropriate standards.
- Pump down refrigerant system, if possible.
  - If a vacuum is not possible, make a manifold so that refrigerant can be removed from various parts of the system.
  - Make sure that cylinder is situated on the scales before recovery takes place.
  - Start the recovery machine and operate in accordance with instructions.
  - Do not overfill cylinders (no more than 80 % volume liquid charge).
  - Do not exceed the maximum working pressure of the cylinder, even temporarily.
  - When the cylinders have been filled correctly and the process completed, make sure that the cylinders and the equipment are removed from site promptly and all isolation valves on the equipment are closed off.
  - Recovered refrigerant shall not be charged into another REFRIGERATING SYSTEM unless it has been cleaned and checked.

## Labelling Decommission Machines

Equipment shall be labelled stating that it has been de-commissioned and emptied of refrigerant. The label shall be dated and signed. For appliances containing FLAMMABLE REFRIGERANTS, ensure that there are labels on the equipment stating the equipment contains FLAMMABLE REFRIGERANT.

## Refrigerant Recovery

- When removing refrigerant from a system, either for servicing or decommissioning, it is recommended good practice that all refrigerants are removed safely.
- When transferring refrigerant into cylinders, ensure that only appropriate refrigerant recovery cylinders are employed. Ensure that the correct number of cylinders for holding the total system charge is available. All cylinders to be used are designated for the recovered refrigerant and labelled for that refrigerant (i.e. special cylinders for the recovery of refrigerant). Cylinders shall be complete with pressure-relief valve and associated shut-off valves in good working order. Empty recovery cylinders are evacuated and, if possible, cooled before recovery occurs.
- The recovery equipment shall be in good working order with a set of instructions concerning the equipment that is at hand and shall be suitable for the recovery of all appropriate refrigerants including, when applicable, FLAMMABLE REFRIGERANTS. In addition, a set of calibrated weighing scales shall be available and in good working order. Hoses shall be complete with leak-free disconnect couplings and in good condition. Before using the recovery machine, check that it is in satisfactory working order, has been properly maintained and that any associated electrical components are sealed to prevent ignition in the event of a refrigerant release. Consult manufacturer if in doubt.
- The recovered refrigerant shall be returned to the refrigerant supplier in the correct recovery cylinder, and the relevant waste transfer note arranged. Do not mix refrigerants in recovery units and especially not in cylinders.
- If compressors or compressor oils are to be removed, ensure that they have been evacuated to an acceptable level to make certain that FLAMMABLE REFRIGERANT does not remain within the lubricant. The evacuation process shall be carried out prior to returning the compressor to the suppliers. Only electric heating to the compressor body shall be employed to accelerate this process. When oil is drained from a system, it shall be carried out safely.

# Service - Troubleshooting

## CAUTION!

TROUBLESHOOTING SHOULD BE PERFORMED BY A QUALIFIED HVAC TECHNICIAN.

| Symptom   | Possible Reason  | Troubleshooting Procedure   |
|---|--|---|
| Fan is not running. Dehumidification or fan is being called for.  | <ol style="list-style-type: none"> <li>1. Loose connection in fan circuit.</li> <li>2. Obstruction prevents fan impeller rotation.</li> <li>3. Defective fan.</li> <li>4. Defective fan relay.</li> </ol>  | <p> <b>WARNING!</b></p> <p><b>ELECTRICAL SHOCK HAZARD:</b><br/>ELECTRICAL POWER MUST BE PRESENT TO PERFORM SOME TESTS. THESE TESTS SHOULD BE PERFORMED BY A QUALIFIED SERVICE PERSON.</p> <p><b>Troubleshooting Procedure for Performance Related Issues</b></p> <p>This method of diagnosis is used to function check the internal components in the dehumidifier. This is to be used when a performance issue is suspected.</p> <ol style="list-style-type: none"> <li>1. Set the humidity controller all the way to the most humid setting or off position – Did the unit shut off?</li> <li>2. If yes, turn the fan setting to the ON position – does the fan start?</li> <li>3. If fan starts, leave in the fan ON position and set the humidity all the way to driest setting. May have to wait 5 minutes for the compressor to start.</li> <li>4. Listen for a distinct buzzing/humming sound of a compressor starting up – do you hear this noise?</li> <li>5. If compressor is running and continues to run, after about 15 minutes you should feel a slight increase in air temperature being discharged out of the discharge air side of the unit.</li> <li>6. If so, depending on your environmental conditions (temp/Rh%), you should see some water production out of the hose within 30 minutes or so. <i>(Note: If the room temperature is 55 degrees or below and/or in area of low relative humidity, the dehumidifier will produce little to no water.)</i></li> <li>7. Collecting the water removed in a 24 hour period will give a measurement of performance.</li> </ol> |
| Low dehumidification capacity (evaporator is frosted continuously). Dehumidification is being called for. | <ol style="list-style-type: none"> <li>1. Defrost thermostat loose or defective.</li> <li>2. Low refrigerant charge.</li> <li>3. Dirty air filter(s) or air flow restricted.</li> <li>4. Excessively restrictive ducting connected to unit.</li> </ol>   |   |
| Dehumidifier removes some water, but not as much as expected.   | <ol style="list-style-type: none"> <li>1. Air temperature and/or humidity have dropped.</li> <li>2. Humidity meter and or thermometer used are out of calibration.</li> <li>3. Unit has entered defrost cycle.</li> <li>4. Dirty air filter(s) or air flow is restricted.</li> <li>5. Defective defrost thermostat.</li> <li>6. Low refrigerant charge.</li> <li>7. Air leak such as loose cover or ducting leaks.</li> <li>8. Defective compressor.</li> <li>9. Restrictive ducting.</li> </ol> |   |



# Service - Troubleshooting

## CAUTION!

TROUBLESHOOTING SHOULD BE PERFORMED BY A QUALIFIED HVAC TECHNICIAN.

| Symptom  | Possible Reason   |
|--|---|
| Neither fan nor compressor running. Dehumidification is being called for.        | <ol style="list-style-type: none"> <li>1. Dehumidifier unplugged or no power to outlet.</li> <li>2. Humidity control set too high.</li> <li>3. Loose connection in internal or control wiring.</li> <li>4. Defective compressor relay.</li> </ol>   |
| Compressor is not running. Dehumidification is being called for. Fan is running. | <ol style="list-style-type: none"> <li>1. Defective compressor run capacitor.</li> <li>2. Loose connection in compressor circuit.</li> <li>3. Defective compressor overload.</li> <li>4. Defective compressor.</li> <li>5. Defrost thermostat open.</li> </ol>  |
| Compressor cycles on and off. Dehumidification is being called for.              | <ol style="list-style-type: none"> <li>1. Low ambient temperature and/or humidity causing unit to cycle through defrost mode.</li> <li>2. Defective compressor overload.</li> <li>3. Defective compressor.</li> <li>4. Defrost thermostat defective.</li> <li>5. Dirty air filter(s) or air flow restricted.</li> <li>6. Defective fan or relay.</li> </ol> |

## WARNING!

SERVICING THE SANTA FE CLASSIC, WITH ITS HIGH PRESSURE REFRIGERANT SYSTEM AND HIGH VOLTAGE CIRCUITRY PRESENTS A HEALTH HAZARD WHICH COULD RESULT IN DEATH, SERIOUS BODILY INJURY, AND/OR PROPERTY DAMAGE. ONLY QUALIFIED SERVICE PEOPLE SHOULD SERVICE THIS UNIT.

### Refrigerant Charging

If the refrigerant charge is lost due to service or a leak, a new charge must be accurately weighed in. If any of the old charge is left in the system, it must be recovered before weighing in the new charge. Refer to the unit nameplate for the correct charge weight and refrigerant type.

### Compressor/Capacitor Replacement

This compressor is equipped with a two terminal external overload and a run capacitor, but no start capacitor or relay.



# Electrical Requirements

The Santa Fe Classic plugs into a common grounded 115VAC outlet. The device draws 7.5A at 104°F and 36%RH. Locate the dehumidifier in an area where the cord's length (9') easily reaches a 115 VAC electrical outlet with a minimum of 15 Amp circuit capacity. If used in an area that may become wet, a GFCI protected circuit is recommended. The unit should not be used in areas prone to flooding. Consult local electrical codes for any further information.

An optional remote dehumidistat is available for use with the Santa Fe Classic and is to be located remotely from the dehumidifier.

## ⚠ CAUTION!

**ELECTRICAL SHOCK HAZARD:** Electrical power must be present to perform some tests. These tests should be performed by a qualified service person.

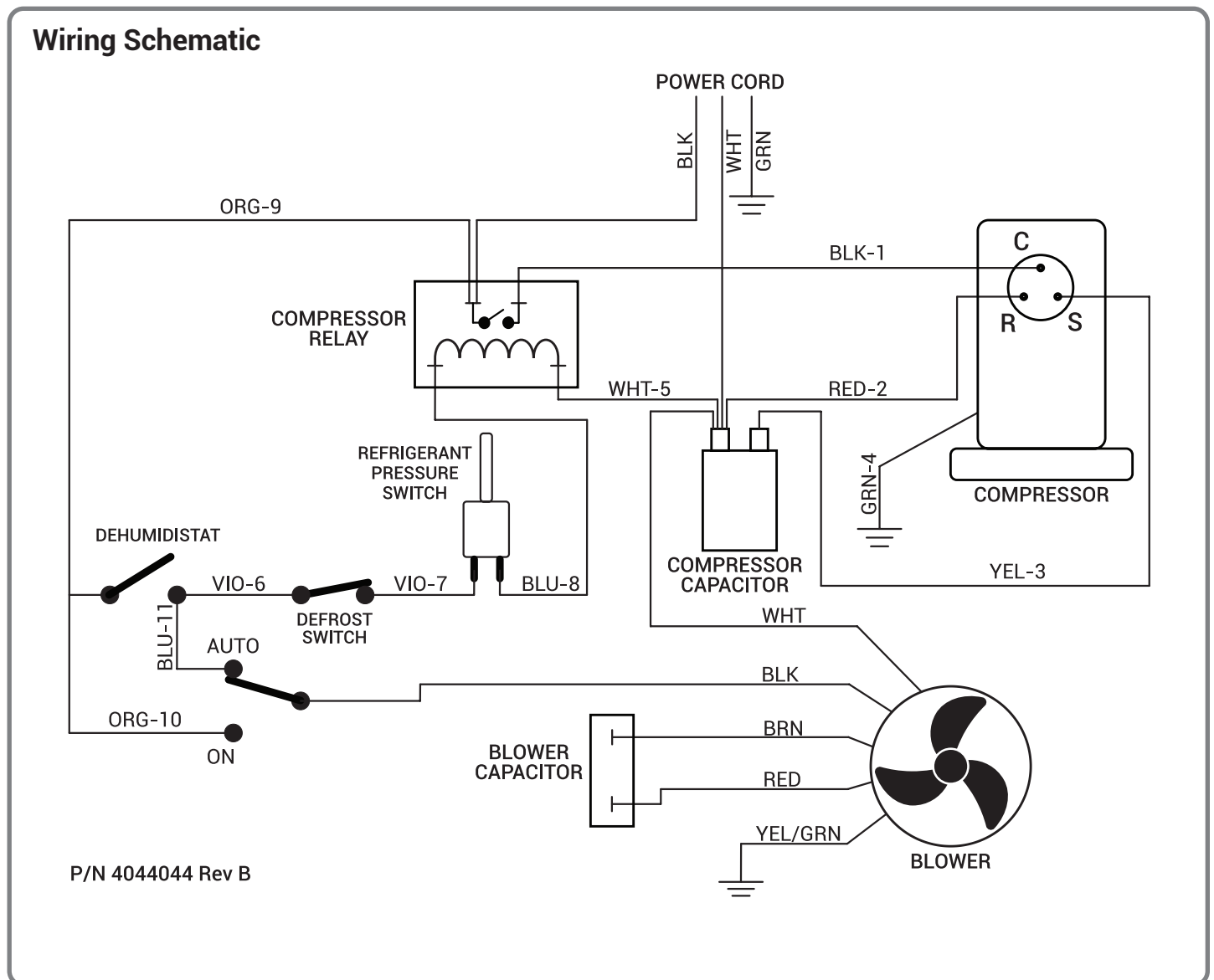

# Warranty

---

Effective January 1, 2024

**Limited Warranty.** Therma-Stor, LLC ("Therma-Stor") warrants as follows: (i) Santa Fe dehumidifiers ("Product") will be free of material defects in workmanship or materials for a period of 5 years ("Five-Year Warranty") following the date of initial purchase of such Product by an original customer purchasing from Therma-Stor or an authorized reseller ("Customer"); and (ii) the Product's components will be free of material defects in workmanship or materials for a period of six (6) years following the date of initial purchase of such Product by a Customer.

**Limitation of Remedies.** CUSTOMER'S SOLE AND EXCLUSIVE REMEDY UNDER THE ABOVE LIMITED WARRANTY AND THERMA-STOR'S ENTIRE LIABILITY THEREUNDER, SHALL BE, AT THE SOLE OPTION OF THERMA-STOR, REPLACEMENT OR REPAIR OF SUCH PRODUCT OR ITS COMPONENTS ("COMPONENTS") BY THERMA-STOR OR THERMA-STOR'S AGENTS ONLY. REFRIGERANT, PIPING, SUPPLIES, TRANSPORTATION COSTS, LABOR COSTS INCURRED IN REPAIR OR REPLACEMENT OF SUCH COMPONENTS ARE NOT INCLUDED. THIS DISCLAIMER AND EXCLUSION SHALL APPLY EVEN IF THE EXPRESS WARRANTY AND LIMITED REMEDY SET FORTH HEREIN FAILS OF ITS ESSENTIAL PURPOSE. CUSTOMER ACKNOWLEDGES THAT NO REPRESENTATIVE OF THERMA-STOR OR OF ITS AFFILIATES OR RESELLERS IS AUTHORIZED TO MAKE ANY REPRESENTATION OR WARRANTY ON BEHALF OF THERMA-STOR OR ANY OF ITS AFFILIATES OR RESELLERS THAT IS NOT IN THIS AGREEMENT.

**Disclaimer of Warranties.** EXCEPT FOR ABOVE LIMITED WARRANTY, WHICH IS THE SOLE AND EXCLUSIVE WARRANTY PROVIDED WITH RESPECT TO THE PRODUCT AND ITS COMPONENTS, THERMA-STOR HEREBY DISCLAIMS ALL EXPRESS AND IMPLIED WARRANTIES, INCLUDING, WITHOUT LIMITATION, THE IMPLIED WARRANTIES OF MERCHANTABILITY AND FITNESS FOR A PARTICULAR PURPOSE.

**Warranty Limitations.** The foregoing limited warranty extends only to a Customer and shall be null and void upon attempted assignment or transfer. A "defect" under the terms of the limited warranty shall not include problems resulting from Customer's or Customer's employees', agents', invitees' or a third party's misuse, improper installation, improper design of any system in which the Product is included, abuse, lack of normal care, failure to follow written instructions, tampering, improper repair, or freezing, corrosion, acts of nature or other causes not arising out of defects in Therma-Stor's workmanship or material. If a Product or Component is replaced while under warranty, the applicable limited warranty period shall not be extended beyond the original warranty time period. The limited warranty does not cover any costs related to changes to a Product or Component that may be required by any codes, laws, or regulations that may become effective after initial purchase of the Product by Customer.

**Customer Responsibilities.** As a further condition to obtaining warranty coverage hereunder, the Customer must send a valid warranty claim to Therma-Stor such that Therma-Stor receives such claim prior to the end of the applicable warranty period. Therma-Stor shall have no obligation hereunder with respect to any claim received by Therma-Stor after the expiration of the applicable warranty period. As a further condition to obtaining warranty coverage hereunder, the Customer must present forms of invoices evidencing proof of purchase of a Product. If such invoices do not clearly indicate the date of initial purchase by a Customer, the applicable Product's date of manufacture will be used instead of the date of initial purchase for the purpose of calculating the commencement of the applicable warranty period. Warranty service must be performed by Therma-Stor or a servicer authorized by Therma-Stor. In order to obtain warranty service, the Customer should call Therma-Stor at 1-800-533-7533 and ask for the Therma-Stor Products Service Department, which will then arrange for applicable warranty service. Warranty service will be performed during customary, daytime working hours. If the Product must be shipped for service, Customer shall be solely responsible for properly packaging the Product, for all freight charges, and for all risk of loss associated with shipment.

**Limitation of Liability.** IN NO EVENT SHALL THERMA-STOR, IN CONNECTION WITH THE DESIGN, SALE, INSTALLATION, USE, REPAIR, REPLACEMENT OR PERFORMANCE OF ANY PRODUCT, COMPONENT, PART THEREOF OR WRITTEN MATERIAL PROVIDED THEREWITH, BE LIABLE, TO THE EXTENT ALLOWED UNDER APPLICABLE LAW, UNDER ANY LEGAL THEORY FOR ANY SPECIAL, DIRECT, INDIRECT, COLLATERAL OR CONSEQUENTIAL DAMAGES OF ANY KIND. NOTWITHSTANDING THE ABOVE LIMITATIONS AND WARRANTIES, THE SOLE AND EXCLUSIVE LIABILITY OF THERMA-STOR, REGARDLESS OF THE NATURE OR THEORY OF THE CLAIM, SHALL UNDER NO CIRCUMSTANCES EXCEED THE PURCHASE PRICE OF THE PRODUCT, COMPONENT OR PART UPON WHICH THE CLAIM IS PREMISED.

**Applicable Law and Venue.** ANY ARBITRATION, ENFORCEMENT OF AN ARBITRATION OR LITIGATION RELATED TO THE PRODUCT WILL BE BROUGHT EXCLUSIVELY IN DANE COUNTY, WISCONSIN, AND CUSTOMER CONSENTS TO THE JURISDICTION OF THE FEDERAL AND STATE COURTS LOCATED THEREIN, SUBMITS TO THE JURISDICTION THEREOF AND WAIVES THE RIGHT TO CHANGE VENUE. CUSTOMER FURTHER CONSENTS TO THE EXERCISE OF PERSONAL JURISDICTION BY ANY SUCH COURT WITH RESPECT TO ANY SUCH PROCEEDING.

**Miscellaneous.** If any term or condition of this Limited Warranty is found by a court of competent jurisdiction to be invalid, illegal or otherwise unenforceable, the same shall not affect the other terms or conditions hereof or thereof or the whole of this Limited Warranty. Any delay or failure by Therma-Stor to exercise any right or remedy will not constitute a waiver of Therma-Stor to thereafter enforce such rights.



# WARRANTY REGISTRATION CARD

**IMPORTANT WARRANTY INFORMATION - DO NOT DISCARD**

**REGISTER YOUR PRODUCT.**

**WARRANTY**

**WARRANTY**

SERIAL  
NUMBER ▶

PART  
NUMBER ▶

[www.thermastor.com/registration](http://www.thermastor.com/registration)

**Register your product  
using the serial number  
and part number above at  
[www.thermastor.com/registration](http://www.thermastor.com/registration)**

**This is important  
Warranty Information.  
Please DO NOT DISCARD!**

[Santa-Fe-Products.com](http://Santa-Fe-Products.com)  
1.800.533.7533

