

INSTALLATION & OPERATION INSTRUCTIONS



The **Santa Fe Classic** has a vertical configuration and its' flow-down design performs exceptionally well in basements. The high capacity blower on the unit moves air in a way that no small conventional unit can. The Classic's optional condensate pump and ducting kits provide the flexibility necessary for any application.

Serial Number _____

Install Date _____

Sold By _____



Patent: thermastor.com/patents

Table of Contents

Safety Instructions	3
Intended Applications	3
Registrations	3
Dehumidifier Set Up	4
Items Included In Box.....	4
Important Precautions	4
Location Considerations.....	4
Drain Installation	5
Operation	6
Humidity Control Adjustment.....	6
Defrost Cycle	6
Fan Operation	6
Air Filtration	7
Changing The Filter	7
Ducting to Finished Areas (Optional)	8
Attaching Duct Collars	8
Recommended Installations.....	9
Service	10
Troubleshooting	10
Refrigerant Charging	11
Compressor / Capacitor Replacement.....	11
Electrical Requirements	12
Warranty	13



4201 Lien Rd. Madison, WI 53704

1-800-533-7533

www.Thermastor.com | www.Santa-Fe-Products.com

© 2016 Therma-Stor LLC

Safety Instructions

READ THE INSTALLATION, OPERATION AND MAINTENANCE INSTRUCTIONS CAREFULLY BEFORE INSTALLING AND OPERATING THIS DEVICE. PROPER ADHERENCE TO THESE INSTRUCTIONS IS ESSENTIAL TO OBTAIN MAXIMUM BENEFIT FROM YOUR SANTA FE DEHUMIDIFIER.

WARNING!

THIS SYMBOL MEANS IMPORTANT INSTRUCTIONS. FAILURE TO HEED THEM CAN RESULT IN SERIOUS INJURY OR DEATH.

CAUTION!

THIS SYMBOL MEANS IMPORTANT INSTRUCTIONS. FAILURE TO HEED THEM CAN RESULT IN INJURY OR MATERIAL PROPERTY DAMAGE.

- Never operate a unit with a damaged power cord. If the power cord is damaged, it must be replaced by the manufacturer, its service agent, or a similarly qualified person in order to avoid a hazard.
- Do not unplug the unit by pulling on the cord. Grasp the plug firmly and pull it out of the wall socket or power receptacle.
- When plugging in the unit, use a Ground Fault Interrupter outlet.
- This appliance is not intended for use by persons (including children) with reduced physical, sensory or mental capabilities, or lack of experience or knowledge, unless they have been given supervision or instruction concerning the use of the appliance by a person responsible for their safety. Children should be supervised to ensure that they do not play with the appliance.
- Never operate electrical equipment near or in standing water.
- Do not stick your fingers or other objects through the safety grill.
- The unit must be used in the upright position.
- When changing filters, do not stick fingers or other objects in the unit, and make sure dehumidifier is off.
- Do not restrict airflow in to or out of the unit. This may cause the unit to overheat.
- The unit should never be serviced or cleaned while it is plugged in.
- Do not sit or stand on the unit, or use as a shelf or table.
- Before leaving the unit unattended, ensure children do not have access to the equipment. Do not allow children to play with or near the unit or in its air flow.
- The unit is designed to be installed indoors only.
- Contact installer or call 1-800-533-7533 for all repair or warranty needs.

Intended Application(s)

The Santa Fe Classic is intended for use in basements: however, the unit can be placed in almost any residential setting where dehumidification is desired. Use in non-residential applications and pool areas may void warranty.

The Santa Fe Classic is designed to operate in temperatures between 56° and 95°F.

In order to efficiently control humidity levels, the area in which the dehumidifier is to be operated must be free of water intrusion or excessive fresh (outside) air infiltration. Before installing the Santa Fe Classic, water intrusion and air infiltration problems should be addressed.

Registrations



The Santa Fe Classic conforms to unified standard UL 60335-2-40 and CSA standard C22.2.60335-2-40.

Dehumidifier Set Up

When unpacking make sure to remove corrugated shipping cardboard from top of unit.

Items Included in Box:

- Santa Fe Classic Dehumidifier
- Santa Fe Classic Installation & Operation Instructions
- MERV-13 Filter (Dimensions: 1.75" x 15.50" x 19.50")
- Drain Hose Attached to Dehumidifier (6')

Important Precautions

- Do not install the Santa Fe Classic with the intake or exhaust of the unit within 1' of a wall or other obstruction. Avoid directing the discharge air at people. The dehumidifier should be used in the upright position.
- Do not place the unit where curtains or debris can be drawn into the intake and restrict airflow.
- The device is designed to be installed indoors in a space that is protected from rain and flooding.
- Do not operate in standing water or place the unit near open water. If used near a water source; be certain there is no chance the unit could fall into the water or get splashed and that it is plugged into a dedicated circuit and Ground Fault Circuit Interrupter (GFCI) protected outlet.
- Install the unit with enough space to access the front panel (label side) and the discharge air flow side of the unit for maintenance and service. The front, label side panel needs to be removed in order to do repairs.
- DO NOT use the dehumidifier as a bench or table.
- DO NOT place the dehumidifier directly on structural building members without vibration absorbers or unwanted noise may result.

Location Considerations

- Locate the dehumidifier near a suitable drain (6' drain hose included). Allow for proper drainage and routing of needed drain pipes.
- Locate the dehumidifier in an area where the cord's length (9') easily reaches a 115 VAC electrical outlet with a minimum of a 15 Amp circuit capacity.
- The unit is designed to operate while level. Failure to level the unit may result in leakage or improper drainage.
- A flooded unit is not covered by warranty.
- Allow sufficient clearance to handle the unit's overall dimensions as well as any optional return and supply ductwork to the unit.
- Allow sufficient clearance for filter removal and to prevent airflow obstruction.
- Electrical service access will require the removal of the front panel. Allow sufficient clearance around the unit.

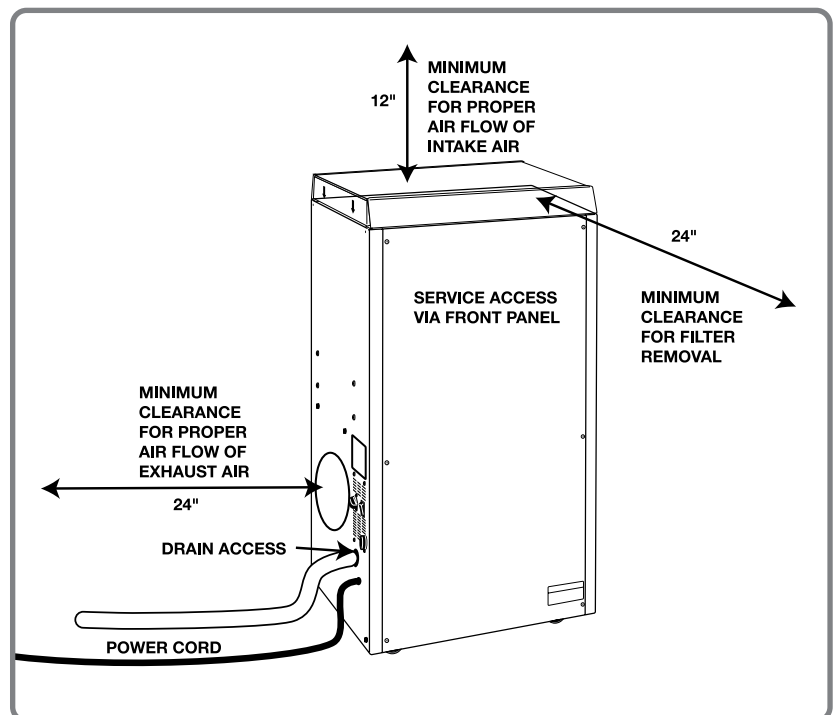

Drain Installation

The Santa Fe Classic generates condensate. A 6' condensate hose comes attached to the unit. Be sure the hose is not kinked or otherwise restricted so water can pass through the hose freely. If the Santa Fe Classic is located too far from the floor drain and the provided hose does not reach, you may use a 1/2" PVC rigid pipe to extend the drain. Rigid PVC tubing is readily available from your local hardware store. Be sure the extension is at a downward slope to the drain.

An optional condensate pump kit is available for use with the Santa Fe Classic and may be installed if lift is required to dispose of condensate. Condensate is automatically pumped to a remote location when the water level in the pump's reservoir rises to close the float switch.

Note: An optional condensate pump kit (Part # 4022220) can be purchased from a local dealer or online.

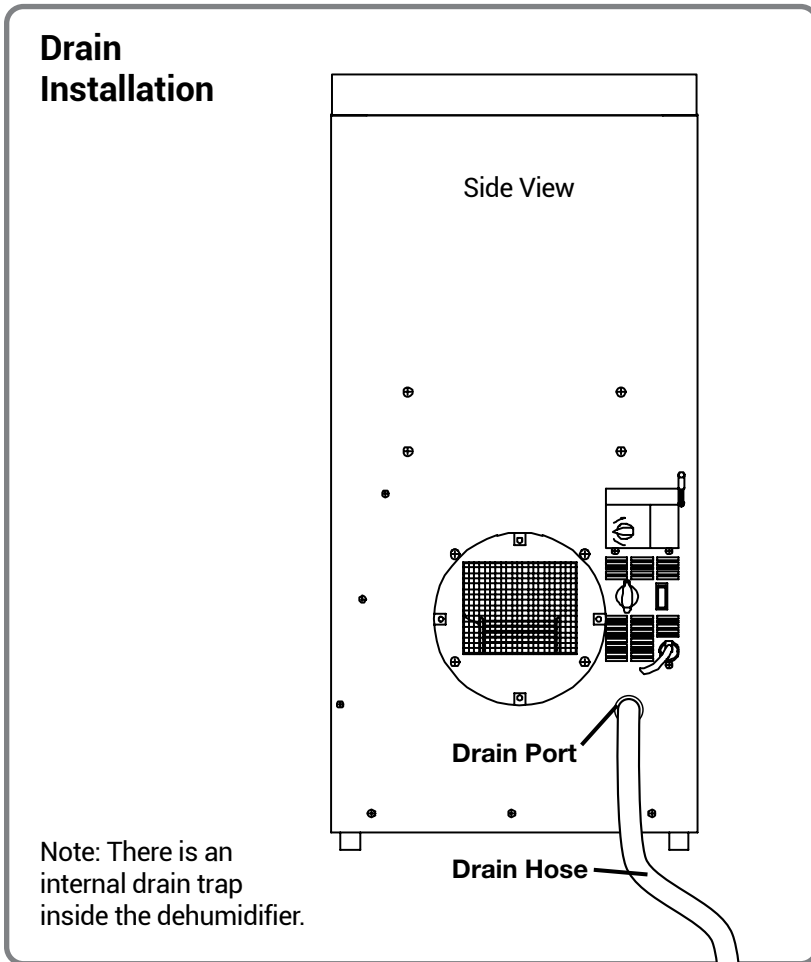

⚠ CAUTION!

CHECK DRAIN HOSE WHEN CHANGING FILTER TO ENSURE THERE IS NOT BUILD UP OF ALGAE OR SLUDGE.

Operation

Humidity Control Adjustment

The humidity control is an adjustable switch that turns the dehumidifier on and off. It turns on when the relative humidity (RH) rises to the dial set point. It turns off when the RH is within $\pm 5\%$ of the set point.

Approximate Humidity Levels Per Setting

"Drier"	35% to 45% Relative Humidity
"Normal"	45% to 55% Relative Humidity (Recommended for most applications)
"Humid"	55% to 65% Relative Humidity

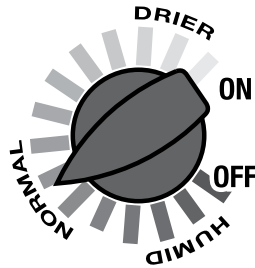

FAN SWITCH

FAN ON: Fan runs continuously



FAN AUTO:
Fan runs only while dehumidifying

⚠ CAUTION!

The dehumidifier will run continuously until the RH is reduced to the humidity control dial setting. It is not recommended to set the humidity control to "dry" in rooms under 65°; doing so will result in long periods of ineffective dehumidifier run time.

To turn unit on, turn the humidity dial clockwise to the recommended "NORMAL" position and set fan control to "FAN AUTO." To turn the unit off, turn the humidity dial counter clockwise to the "OFF" position and set fan control to "FAN AUTO."



The Acurite Hygrometer (part number 4038844) is available to accurately monitor humidity levels. Please contact your dealer or order online.

Defrost Cycle

This product includes a defrost thermostat. This feature prevents internal damage caused by excessive frost forming within the unit. When the unit is experiencing excessive frost the system will stop dehumidifying and the fan will run until normal operating conditions are present.

Fan Operation

Turning the fan switch "FAN ON" will cause the unit's internal blower to run continuously, whether the unit is dehumidifying or not. This function is desirable if the unit is used for air circulation or filtration. Turning the fan switch to "FAN AUTO" (recommended) will cause the unit's internal blower to run only while the unit is dehumidifying.

Air Filtration

The Santa Fe Classic is equipped with a MERV-13 air filter (89-90% ASHRAE dust spot). An optional MERV-11 filter is available at www.ThermastorFilters.com. The MERV-13 filter should be checked and replaced every three to six months. Operating the unit with a dirty filter will reduce dehumidifier capacity and efficiency.

DO NOT operate the unit without the standard MERV-13 or optional MERV-11 filter. Filter non-compliance voids the product warranty.

CAUTION!

MAKE SURE UNIT IS OFF BEFORE CHANGING THE FILTER. FAILURE TO FOLLOW FILTER HANDLING INSTRUCTIONS MAY RESULT IN IMPROPER FUNCTION OF THE DEHUMIDIFIER AND CAUSE PREMATURE FILTER WEAR OR UNIT DAMAGE.

Changing the Filter

For greatest filtration and efficiency of the Santa Fe Classic, it is recommended that the MERV-13 filter be replaced every three to six months

Step 1 - Remove the filter by pulling it gently out of the unit from the front side.

Step 2 - Insert the new filter by gently sliding it back into place inside the unit. Be sure the arrows on the filter are pointing down towards the unit.

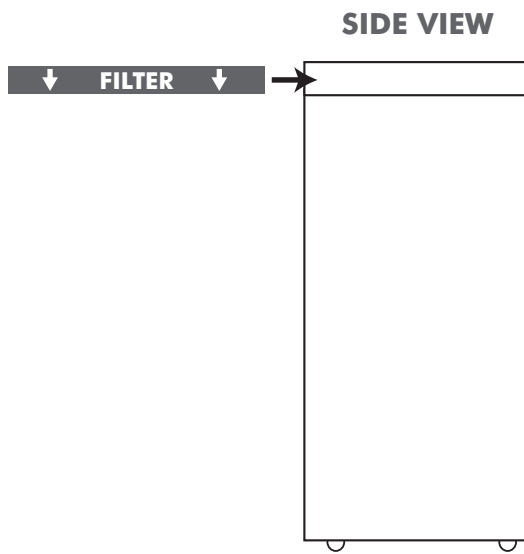
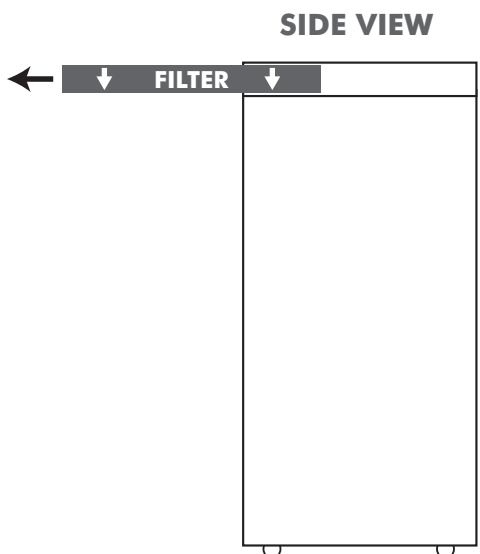

CAUTION!

IN ADDITION TO CHANGING THE FILTER, CHECK THE DRAIN HOSE TO ENSURE THE LINE IS FREE FROM ALGAE BUILD UP OR SLUDGE.

Ducting To Finished Areas (Optional)

Attaching Duct Collars

Return Air Inlet Hood

The return air inlet hood has an 8" and 6" diameter collar. The 8" collar is the main return collar and must be used. The 6" collar is optional and can be left closed to draw air from another location.

Supply Air Outlet

The 8" supply collar is included in the return duct kit and also sold separately.

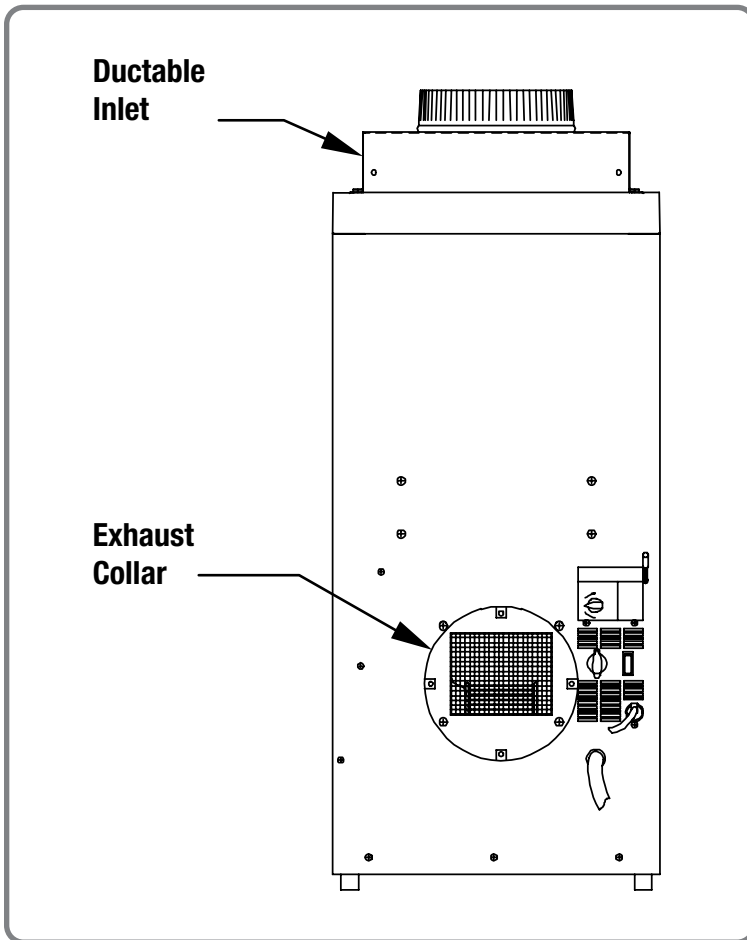

Ducting To Finished Areas (Optional)

Recommended Installations

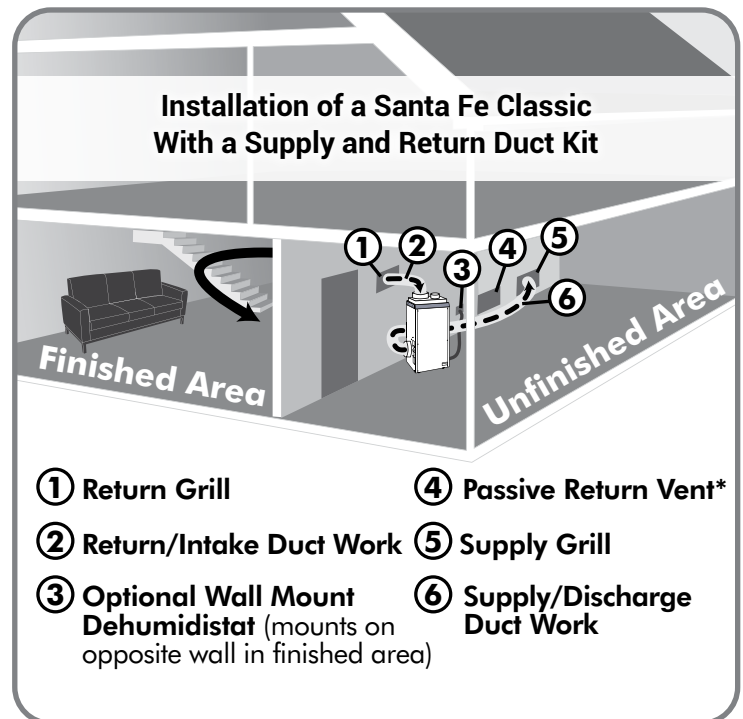
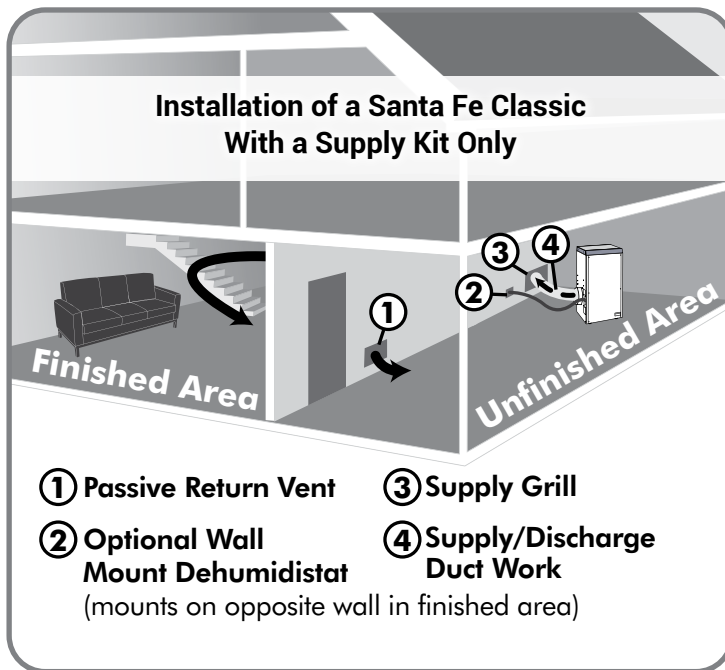

- Place the Santa Fe Classic in the unfinished area of the basement, near a drain access (condensate will drain via gravity or with an optional pump kit).
- Using the supply duct collar, supply the dry air from the dehumidifier into a large, open area in the finished section of the basement.
- Place a return grill / passive vent on the other side of the wall that separates the finished and unfinished areas. This will allow for a circular air flow throughout the basement.
- The passive grill will prevent the unfinished room from being placed under a negative pressure and also allow the dehumidifier to focus on keeping the unfinished area dry as well.
- The onboard dehumidistat control can be used on the unit for this application or a 120 volt dehumidistat can be placed in the finished basement as well (we recommend using an electrician to run the wiring).
- Be sure to keep all doors open to any other rooms in the basement to help with proper air circulation (bedrooms, bathrooms, etc.)

- Place the Santa Fe Classic in the unfinished area of the basement, near a drain access (condensate will drain via gravity or with an optional pump kit).
- Using the supply and return duct kit, supply the dry air from the dehumidifier into a large, open area of the finished basement. Use the return duct kit to draw air back through the dehumidifier.
- Be sure the return and supply are at least 10 feet away from each other for proper air flow throughout the basement. Add a passive grill between the finished and unfinished areas (*or have a 2" gap under the door separating the two rooms). This will help keep the unfinished area dry as well.
- Use the 120 volt, wall mounted dehumidistat for this installation for proper run time on the dehumidifier (we recommend using an electrician to install the separate 120 volt control).
- Be sure to keep all doors open to any other rooms in the basement to help with proper air circulation (bedrooms, bathrooms, etc.)

Service - Troubleshooting

CAUTION!

TROUBLESHOOTING SHOULD BE PERFORMED BY A QUALIFIED HVAC TECHNICIAN.

Symptom	Possible Reason	Troubleshooting Procedure
Fan is not running. Dehumidification or fan is being called for.	<ol style="list-style-type: none"> 1. Loose connection in fan circuit. 2. Obstruction prevents fan impeller rotation. 3. Defective fan. 4. Defective fan relay. 	<p> WARNING!</p> <p>ELECTRICAL SHOCK HAZARD: ELECTRICAL POWER MUST BE PRESENT TO PERFORM SOME TESTS. THESE TESTS SHOULD BE PERFORMED BY A QUALIFIED SERVICE PERSON.</p> <p>Troubleshooting Procedure for Performance Related Issues</p> <p>This method of diagnosis is used to function check the internal components in the dehumidifier. This is to be used when a performance issue is suspected.</p> <ol style="list-style-type: none"> 1. Set the humidity controller all the way to the most humid setting or off position – Did the unit shut off? 2. If yes, turn the fan setting to the ON position – does the fan start? 3. If fan starts, leave in the fan ON position and set the humidity all the way to driest setting. May have to wait 5 minutes for the compressor to start. 4. Listen for a distinct buzzing/humming sound of a compressor starting up – do you hear this noise? 5. If compressor is running and continues to run, after about 15 minutes you should feel a slight increase in air temperature being discharged out of the discharge air side of the unit. 6. If so, depending on your environmental conditions (temp/Rh%), you should see some water production out of the hose within 30 minutes or so. <i>(Note: If the room temperature is 55 degrees or below and/or in area of low relative humidity, the dehumidifier will produce little to no water.)</i> 7. Collecting the water removed in a 24 hour period will give a measurement of performance.
Low dehumidification capacity (evaporator is frosted continuously). Dehumidification is being called for.	<ol style="list-style-type: none"> 1. Defrost thermostat loose or defective. 2. Low refrigerant charge. 3. Dirty air filter(s) or air flow restricted. 4. Excessively restrictive ducting connected to unit. 	
Dehumidifier removes some water, but not as much as expected.	<ol style="list-style-type: none"> 1. Air temperature and/or humidity have dropped. 2. Humidity meter and or thermometer used are out of calibration. 3. Unit has entered defrost cycle. 4. Dirty air filter(s) or air flow is restricted. 5. Defective defrost thermostat. 6. Low refrigerant charge. 7. Air leak such as loose cover or ducting leaks. 8. Defective compressor. 9. Restrictive ducting. 	

Service - Troubleshooting

CAUTION!

TROUBLESHOOTING SHOULD BE PERFORMED BY A QUALIFIED HVAC TECHNICIAN.

Symptom	Possible Reason
Neither fan nor compressor running. Dehumidification is being called for.	<ol style="list-style-type: none"> 1. Dehumidifier unplugged or no power to outlet. 2. Humidity control set too high. 3. Loose connection in internal or control wiring. 4. Defective compressor relay.
Compressor is not running. Dehumidification is being called for. Fan is running.	<ol style="list-style-type: none"> 1. Defective compressor run capacitor. 2. Loose connection in compressor circuit. 3. Defective compressor overload. 4. Defective compressor. 5. Defrost thermostat open.
Compressor cycles on and off. Dehumidification is being called for.	<ol style="list-style-type: none"> 1. Low ambient temperature and/or humidity causing unit to cycle through defrost mode. 2. Defective compressor overload. 3. Defective compressor. 4. Defrost thermostat defective. 5. Dirty air filter(s) or air flow restricted. 6. Defective fan or relay.

WARNING!

SERVICING THE SANTA FE CLASSIC, WITH ITS HIGH PRESSURE REFRIGERANT SYSTEM AND HIGH VOLTAGE CIRCUITRY PRESENTS A HEALTH HAZARD WHICH COULD RESULT IN DEATH, SERIOUS BODILY INJURY, AND/OR PROPERTY DAMAGE. ONLY QUALIFIED SERVICE PEOPLE SHOULD SERVICE THIS UNIT.

Refrigerant Charging

If the refrigerant charge is lost due to service or a leak, a new charge must be accurately weighed in. If any of the old charge is left in the system, it must be recovered before weighing in the new charge. Refer to the unit nameplate for the correct charge weight and refrigerant type.

Compressor/Capacitor Replacement

This compressor is equipped with a two terminal external overload and a run capacitor, but no start capacitor or relay.

Electrical Requirements

The Santa Fe Classic plugs into a common grounded 115VAC outlet. The device draws 6.4 Amps at 80°F and 60% RH. Locate the dehumidifier in an area where the cord's length (9') easily reaches a 115 VAC electrical outlet with a minimum of 15 Amp circuit capacity. If used in an area that may become wet, a GFCI protected circuit is recommended. The unit should not be used in areas prone to flooding. Consult local electrical codes for any further information.

An optional remote dehumidistat is available for use with the Santa Fe Classic and is to be located remotely from the dehumidifier.

⚠ CAUTION!

ELECTRICAL SHOCK HAZARD: Electrical power must be present to perform some tests. These tests should be performed by a qualified service person.

Wiring Schematic

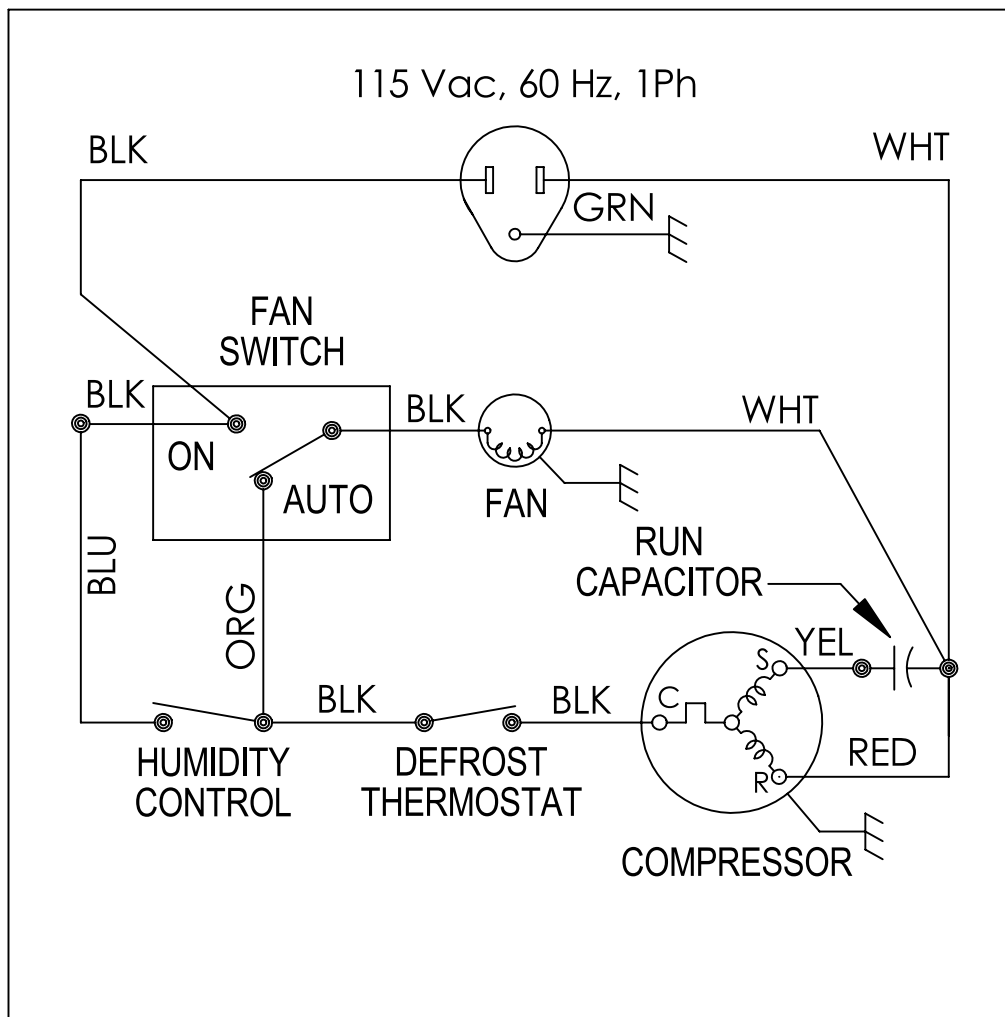

Warranty

Limited Warranty. Therma-Stor, LLC ("Therma-Stor") warrants as follows: (i) the Santa Fe Classic dehumidifier ("Product") will be free of material defects in workmanship or materials for a period of 2 years ("Two-Year Warranty") following the date of initial purchase of such Product by an original customer purchasing from Therma-Stor or an authorized reseller ("Customer"); and (ii) the Product's components will be free of material defects in workmanship or materials for a period of **six (6) years** following the date of initial purchase of such Product by a Customer.

Limitation of Remedies. CUSTOMER'S SOLE AND EXCLUSIVE REMEDY UNDER THE ABOVE LIMITED WARRANTY AND THERMA-STOR'S ENTIRE LIABILITY THEREUNDER, SHALL BE, AT THE SOLE OPTION OF THERMA-STOR, REPLACEMENT OR REPAIR OF SUCH PRODUCT OR ITS COMPONENTS ("COMPONENTS") BY THERMA-STOR OR THERMA-STOR'S AGENTS ONLY. REFRIGERANT, PIPING, SUPPLIES, TRANSPORTATION COSTS, LABOR COSTS INCURRED IN REPAIR OR REPLACEMENT OF SUCH COMPONENTS ARE NOT INCLUDED. THIS DISCLAIMER AND EXCLUSION SHALL APPLY EVEN IF THE EXPRESS WARRANTY AND LIMITED REMEDY SET FORTH HEREIN FAILS OF ITS ESSENTIAL PURPOSE. CUSTOMER ACKNOWLEDGES THAT NO REPRESENTATIVE OF THERMA-STOR OR OF ITS AFFILIATES OR RESELLERS IS AUTHORIZED TO MAKE ANY REPRESENTATION OR WARRANTY ON BEHALF OF THERMA-STOR OR ANY OF ITS AFFILIATES OR RESELLERS THAT IS NOT IN THIS AGREEMENT. Notwithstanding the above, during the term of the Two-Year Warranty only, Therma-Stor will provide, free of charge to Customer, all Components and labor (except costs related to removal and installation of Product) required to fulfill its obligations under such Two-Year Warranty.

Disclaimer of Warranties. EXCEPT FOR ABOVE LIMITED WARRANTY, WHICH IS THE SOLE AND EXCLUSIVE WARRANTY PROVIDED WITH RESPECT TO THE PRODUCT AND ITS COMPONENTS, THERMA-STOR HEREBY DISCLAIMS ALL EXPRESS AND IMPLIED WARRANTIES, INCLUDING, WITHOUT LIMITATION, THE IMPLIED WARRANTIES OF MERCHANTABILITY AND FITNESS FOR A PARTICULAR PURPOSE.

Warranty Limitations. The foregoing limited warranty extends only to a Customer and shall be null and void upon attempted assignment or transfer. A "defect" under the terms of the limited warranty shall not include problems resulting from Customer's or Customer's employees', agents', invitees' or a third party's misuse, improper installation, improper design of any system in which the Product is included, abuse, lack of normal care, failure to follow written instructions, tampering, improper repair, or freezing, corrosion, acts of nature or other causes not arising out of defects in Therma-Stor's workmanship or material. If a Product or Component is replaced while under warranty, the applicable limited warranty period shall not be extended beyond the original warranty time period. The limited warranty does not cover any costs related to changes to a Product or Component that may be required by any codes, laws, or regulations that may become effective after initial purchase of the Product by Customer.

Customer Responsibilities. As a further condition to obtaining warranty coverage hereunder, the Customer must send a valid warranty claim to Therma-Stor such that Therma-Stor receives such claim prior to the end of the applicable warranty period. Therma-Stor shall have no obligation hereunder with respect to any claim received by Therma-Stor after the expiration of the applicable warranty period. As a further condition to obtaining warranty coverage hereunder, the Customer must present forms of invoices evidencing proof of purchase of a Product. If such invoices do not clearly indicate the date of initial purchase by a Customer, the applicable Product's date of manufacture will be used instead of the date of initial purchase for the purpose of calculating the commencement of the applicable warranty period. Warranty service must be performed by Therma-Stor or a servicer authorized by Therma-Stor. In order to obtain warranty service, the Customer should call Therma-Stor at 1-800-533-7533 and ask for the Therma-Stor Products Service Department, which will then arrange for applicable warranty service. Warranty service will be performed during customary, daytime working hours. If the Product must be shipped for service, Customer shall be solely responsible for properly packaging the Product, for all freight charges, and for all risk of loss associated with shipment.

Limitation of Liability. IN NO EVENT SHALL THERMA-STOR, IN CONNECTION WITH THE DESIGN, SALE, INSTALLATION, USE, REPAIR, REPLACEMENT OR PERFORMANCE OF ANY PRODUCT, COMPONENT, PART THEREOF OR WRITTEN MATERIAL PROVIDED THEREWITH, BE LIABLE, TO THE EXTENT ALLOWED UNDER APPLICABLE LAW, UNDER ANY LEGAL THEORY FOR ANY SPECIAL, DIRECT, INDIRECT, COLLATERAL OR CONSEQUENTIAL DAMAGES OF ANY KIND. NOTWITHSTANDING THE ABOVE LIMITATIONS AND WARRANTIES, THE SOLE AND EXCLUSIVE LIABILITY OF THERMA-STOR, REGARDLESS OF THE NATURE OR THEORY OF THE CLAIM, SHALL UNDER NO CIRCUMSTANCES EXCEED THE PURCHASE PRICE OF THE PRODUCT, COMPONENT OR PART UPON WHICH THE CLAIM IS PREMISED.

Applicable Law and Venue. ANY ARBITRATION, ENFORCEMENT OF AN ARBITRATION OR LITIGATION RELATED TO THE PRODUCT WILL BE BROUGHT EXCLUSIVELY IN DANE COUNTY, WISCONSIN, AND CUSTOMER CONSENTS TO THE JURISDICTION OF THE FEDERAL AND STATE COURTS LOCATED THEREIN, SUBMITS TO THE JURISDICTION THEREOF AND WAIVES THE RIGHT TO CHANGE VENUE. CUSTOMER FURTHER CONSENTS TO THE EXERCISE OF PERSONAL JURISDICTION BY ANY SUCH COURT WITH RESPECT TO ANY SUCH PROCEEDING.

Miscellaneous. If any term or condition of this Limited Warranty is found by a court of competent jurisdiction to be invalid, illegal or otherwise unenforceable, the same shall not affect the other terms or conditions hereof or thereof or the whole of this Limited Warranty. Any delay or failure by Therma-Stor to exercise any right or remedy will not constitute a waiver of Therma-Stor to thereafter enforce such rights.



SANTA-FE
DEHUMIDIFIERS

Santa-Fe-Products.com
800.533.7533